

# **3X BEST PERFORMANCE**



**FUSIONCROSS**



**INSERTING:  
THE FUSION SERIES**

✓ **ONE MACHINE TYPE  
FOR ALL APPLICATIONS**

✓ **PATENTED  
FLOW-PRINCIPLE**

✓ **BROADEST RANGE OF  
FORMATS & ENCLOSURES**

✓ **JOB CHANGEOVERS  
IN 90 SECONDS**

✓ **EFFICIENT, INTUITIVE,  
NETWORKED**

## INSERTING TECHNOLOGY OF THE FUTURE

Digital transformation is changing our society, markets and business models and the post-processing industry is no exception. Printing and inserting applications are becoming increasingly specific, with more and more variants, while individual jobs are getting smaller. One of the major challenges in document management is downtime while the machines are being set up due to frequent job changeovers - time when the systems do not earn any money. Manual production steps are also

time-consuming, costly and error-prone. Comprehensive automation, smart networking and flexible, stable systems will be crucial for profitable production in the future and for the ability to react to new requirements at any time. That's why BOWE SYSTEC developed its Fusion Series - a range of inserting systems that are ideal for direct mail and transactional users both now and in the future.

## THE FUSION SERIES AT A GLANCE

### FUSION SPEED

-  High volumes
-  Fastest & most efficient system on the market
-  Highest net output in the industry
-  Your route to the automated mailroom

### FUSION CROSS

-  High volumes
-  Maximum flexibility
-  Broadest range of formats & filling thicknesses
-  True all-rounder

### FUSION LITE

-  Medium volumes
-  Premium technology
-  Outstanding price-performance ratio
-  Very broad range of formats & filling thicknesses

# THE ONLY INSERTER YOU WILL NEED

The three machines in the Fusion Series are currently considered to be the ultimate inserting systems on the market. As true all-rounders, they can cover virtually any application in a mail production center and leave nothing to be desired when it comes to efficiency, flexibility and system availability. The three inserters in this series - the Fusion Lite, Fusion Cross and Fusion Speed - are able to process both transactional and direct mail with absolute precision and stability, convincing with their high performance and the ability to

handle jobs of all sizes with ease. All Fusion Series inserters are intuitive to control and can be networked with each other, meaning job changeovers are a matter of minutes. Their software also enables them to meet the highest integrity demands. In short, document processing that leaves nothing to be desired. The Fusion Series inserters: the only ones you will need for your mailroom.

## NONSTOP PRODUCTION

All Fusion Series inserting systems owe their capabilities to their unique inserting technology, letting the whole production process flow smoothly. The Flow-Principle ensures especially reliable processing while being gentle on both materials and machine, reducing stops to a minimum and delivering the highest net output in the industry. By allowing the actual inserting process more time, it is possible to process a very wide range of envelope formats and enclosures - nonstop.

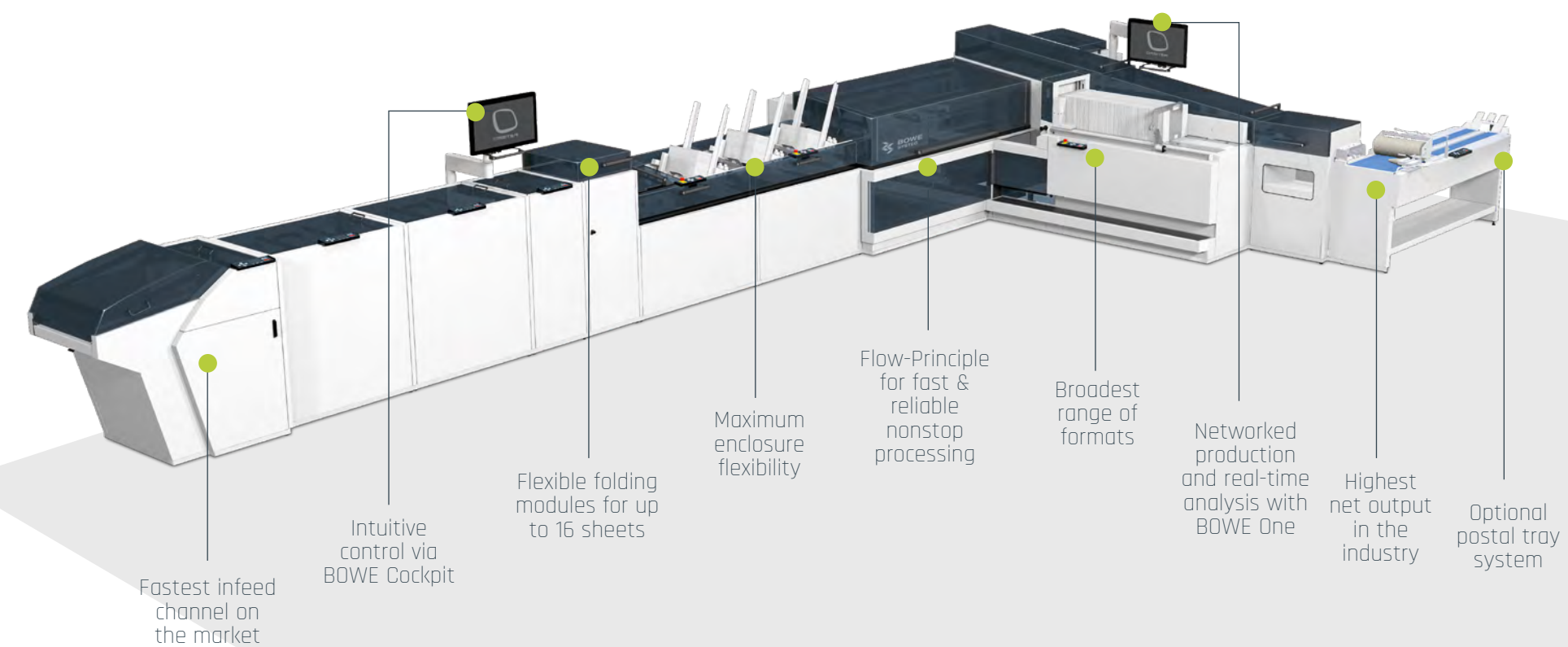

Fastest infeed channel on the market

Intuitive control via BOWE Cockpit

Flexible folding modules for up to 16 sheets

Maximum enclosure flexibility

Flow-Principle for fast & reliable nonstop processing

Broadest range of formats

Networked production and real-time analysis with BOWE One

Highest net output in the industry

Optional postal tray system



Maximum system efficiency thanks to unique inserting technology



Single Machine Type Strategy (SMTS) - one system for virtually all applications



Broadest range of formats and filling thicknesses



Simple and intuitive to operate



Maximum flexibility and future-proof investment thanks to open device carrier concept



Total modularity and a range of options allow a high degree of automation

## THE FUSION SERIES AT A GLANCE

### FUSION SPEED

- High volumes
- Fastest & most efficient system on the market
- Highest net output in the industry
- Your route to the automated mailroom

### JOB CHANGE-OVERS IN NO TIME AT ALL

Small jobs require frequent changeovers, bringing production to a halt. Fusion Series inserters are capable of changing over jobs in just 90 seconds. It couldn't be simpler thanks to the BOWE Cockpit control software specially developed by us. This allows jobs to be prepared and the inserter automatically set up. Even enclosure feeders can be exchanged quickly and easily owing to the open device carrier concept.

### FUSION CROSS

- High volumes
- Maximum flexibility
- Broadest range of formats & filling thicknesses
- True all-rounder

### FUSION LITE

- Medium volumes
- Premium technology
- Outstanding price-performance ratio
- Very broad range of formats & filling thicknesses

MORE INFO AT [BOWE.COM/IQ](http://BOWE.COM/IQ)



## PRECISELY THE RIGHT CHOICE THREE TIMES OVER

Whatever your requirements, a Fusion system is always the right choice. Maximum flexibility combined with high performance, reaching speeds of up to 24,000 insertions per hour in the case of the Fusion Cross. No other system on the market can process such a wide range of enclosure and envelope formats while delivering such outstanding productivity. The system is effortlessly capable of handling formats ranging from B6+ or #7 3/4 up to C4, B4 or Flats. The Fusion Speed lives up to its name with speeds of 30,000 envelopes per hour and the ability to process formats from B6+ to B5 and #7 3/4 to 6 x 9 at top speeds. There is more to the Fusion Lite than its attractive price. It is perfect for anyone who wants to reap the benefits of premium Fusion technology and the full format bandwidth in the mid performance range.

FUSION SPEED

# FUSION SPEED

## MAXIMUM THROUGHOUT, MINIMUM STOPS



High volumes



Fastest & most efficient system on the market



Highest net output in the industry



Your route to the automated mailroom

### TECHNICAL SPECIFICATIONS

Envelope formats	B6+ - B5   #7 3/4 - 6 x 9
Max. speed	30,000 env/h
Max. enclosure thickness	15 mm   0.59"
Number of channels	1 channel
Max. filling thickness	15 mm   0.59"

FUSION CROSS

# FUSION CROSS

## EXCEPTIONAL FLEXIBILITY FOR ALL APPLICATIONS



High volumes



Maximum flexibility



Broadest range of formats & filling thicknesses



True all-rounder

### TECHNICAL SPECIFICATIONS

Envelope formats	B6+ - B4   #7 3/4 - Flats
Max. speed	24,000 env/h
Max. enclosure thickness	15 mm   0.59"
Number of channels	≥ 1 channel
Max. filling thickness	15 mm   0.59"

FUSION LITE

# FUSION LITE

## THE IDEAL COMBINATION OF PERFORMANCE & PRICE



Medium volumes



Premium technology



Outstanding price-performance ratio



Very broad range of formats & filling thicknesses

### TECHNICAL SPECIFICATIONS

Envelope formats	B6+ - B4   #7 3/4 - Flats
Max. speed	16,000 env/h
Max. enclosure thickness	15 mm   0.59"
Number of channels	1 channel
Max. filling thickness	15 mm   0.59"

## THE FUSION SERIES AT A GLANCE

### FUSION SPEED

- High volumes
- Fastest & most efficient system on the market
- Highest net output in the industry
- Your route to the automated mailroom

### FUSION CROSS

- High volumes
- Maximum flexibility
- Broadest range of formats & filling thicknesses
- True all-rounder

### FUSION LITE

- Medium volumes
- Premium technology
- Outstanding price-performance ratio
- Very broad range of formats & filling thicknesses

# THE FLOW-PRINCIPLE UNIQUE INSERTING TECHNOLOGY

All Fusion Series inserters owe their capabilities to their unique, patented Flow-Principle inserting technology. This true example of German engineering sets Fusion inserters apart from any other inserting system. The pioneering inserting principle allows different envelope formats and complex enclosures up to 15 mm thick and weighing up to 1 kg to be processed reliably yet is gentle on both the material and the machine. Take advantage of the Flow-Principle to raise your production efficiency to unprecedented levels.

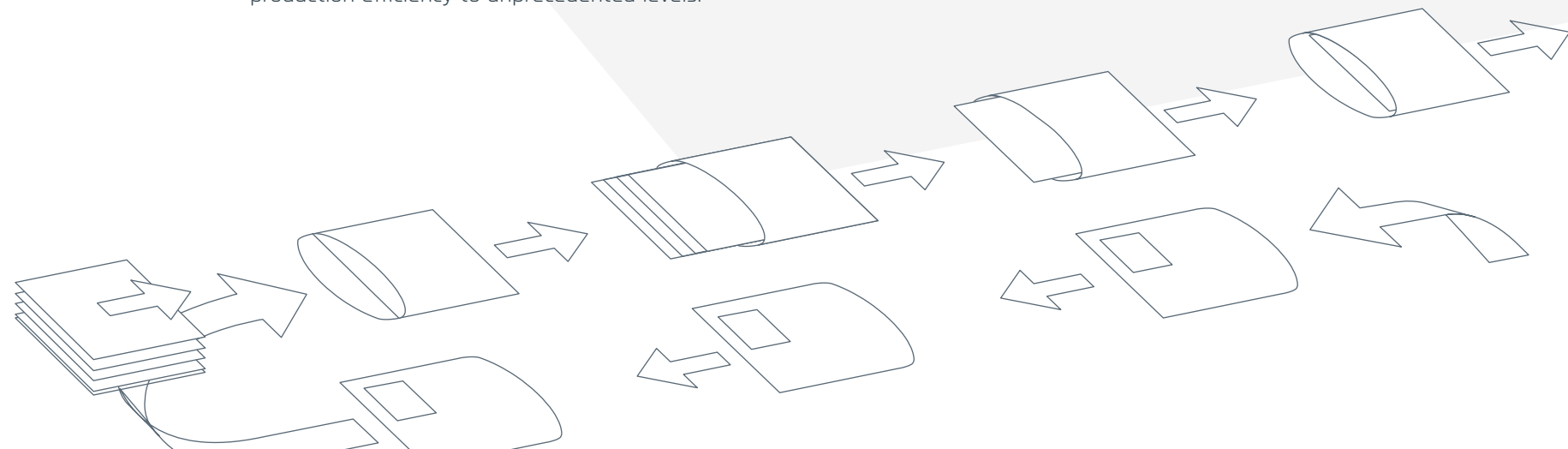

## NONSTOP INSERTING

With the Flow-Principle, BOWE SYSTEC has introduced a completely new approach to inserting, letting the whole production process flow smoothly. Inserting speed is reduced by a factor of 4.5 to allow more time during the inserting procedure. Nevertheless, the overall result is higher output, because only this unique inserting principle allows stable, reliable and flexible processing of very different documents, enclosures and envelopes - all nonstop.

**-4.5x**  
REDUCED FILLING  
SPEED

**+MORE**  
OUTPUT

## THE FUSION SERIES AT A GLANCE

### FUSION SPEED

- High volumes
- Fastest & most efficient system on the market
- Highest net output in the industry
- Your route to the automated mailroom

### FUSION CROSS

- High volumes
- Maximum flexibility
- Broadest range of formats & filling thicknesses
- True all-rounder

### FUSION LITE

- Medium volumes
- Premium technology
- Outstanding price-performance ratio
- Very broad range of formats & filling thicknesses

# BROAD RANGE OF FORMATS

Their unique inserting principle means that - even at very high speeds - Fusion Series systems are able to process an extraordinarily broad range of formats and filling thicknesses stably and reliably. The Fusion Cross does this best of all. No other high-speed inserting system can match it for flexibility and can process such a broad bandwidth of envelope formats. Neither small formats such as B6+ nor outsize ones such as C4, B4 or Flats pose a challenge for this system. Even at very high speeds, the Fusion Cross excels as a solution to all the different requirements of a mailroom - in a single system.

The Fusion Lite too, in the medium performance segment of up to 16,000 envelopes per hour, is able to cover the full range of formats from B6+ to B4. In the high performance segment, the Fusion Speed is capable of top speeds of up to 30,000 envelopes per hour and handles envelope formats from B6+ to B5 with maximum reliability. Quick and simple job changeovers coupled with short setup times round off the Fusion systems portfolio.

# DIFFICULT ENCLOSURES? DON'T EXIST!

## OPEN DEVICE CARRIER CONCEPT

It is also the enclosure feeders that make the Fusion Series so special. The feeders are seated on a freely configurable device carrier so that they can be exchanged easily and flexibly for use on other inserters. With both friction and rotary feeders available, Fusion Series inserters always have the right feeder in reserve for any enclosure. The optional Autoloader delivers enhanced efficiency thanks to the automatic enclosure infeed and reduces operator stress at maximum production speed.

Who knows now what enclosures will need to be processed in the future? That's no problem with Fusion inserters because they bridge the gap between transactional and direct mail: high quality processing of important documents and unconventional enclosures with the highest integrity and at the fastest speeds. Whether thick or thin, rough or smooth, folded or unfolded, no material is too difficult for these machines and their enclosure feeders. This is guaranteed by the highest performing draw-off technologies on the market. Depending on the application, enclosures up to 15 mm thick and weighing up to 1 kg can be fed in. Whatever requirements you might have tomorrow, this high degree of enclosure flexibility means you will be well equipped for all applications - now and in the future!



## THE FUSION SERIES AT A GLANCE

### FUSION SPEED

-  High volumes
-  Fastest & most efficient system on the market
-  Highest net output in the industry
-  Your route to the automated mailroom

### FUSION CROSS

-  High volumes
-  Maximum flexibility
-  Broadest range of formats & filling thicknesses
-  True all-rounder

### FUSION LITE





-  Medium volumes
-  Premium technology
-  Outstanding price-performance ratio
-  Very broad range of formats & filling thicknesses

## THE FUSION SERIES AT A GLANCE

### FUSION SPEED

-  High volumes
-  Fastest & most efficient system on the market
-  Highest net output in the industry
-  Your route to the automated mailroom

### FUSION CROSS

-  High volumes
-  Maximum flexibility
-  Broadest range of formats & filling thicknesses
-  True all-rounder

### FUSION LITE

-  Medium volumes
-  Premium technology
-  Outstanding price-performance ratio
-  Very broad range of formats & filling thicknesses

# FEWER SYSTEMS MORE EFFICIENCY

With their no-compromise performance, unique inserting principle and exceptional enclosure flexibility, Fusion inserters combine all that is needed to guarantee the success of a modern mail production center. Fusion Series systems are able to handle almost anything that a modern mail production center might need to deal with. Fast and reproducible job changeovers, reduced training effort and minimal service and maintenance expenditure make it possible to calculate production costs regardless of the size of a mail production center or the number of systems. What's more, Fusion Series systems deliver such high performance and efficiency that a single Fusion inserter is capable of replacing several inserting systems of another type. Fewer inserting systems, more output!

# TWICE THE OUTPUT HALF THE MANPOWER

Speed is only one aspect of a profitable production center. System intelligence is another. This is especially true for the Fusion Speed, whose exceptional performance can only be exploited to the full if its operators are able to keep pace with the machine's capabilities - and that is only possible through extensive automation. Therefore, all Fusion Series systems come with an intuitive software package. For example, BOWE Cockpit control software considerably simplifies the preparation for and processing of jobs. Format changeovers are carried out automatically, setup times and hence downtime are reduced to a minimum, and errors are prevented. What's more, the machines can optionally be equipped with a postal tray system to take the strain off the operators. Numerous further options for integrating processes currently carried out by hand as well as the incorporation of robots, driverless vehicles and Warehouse Management Systems complement the automation concept perfectly and maximize output while minimizing manpower.



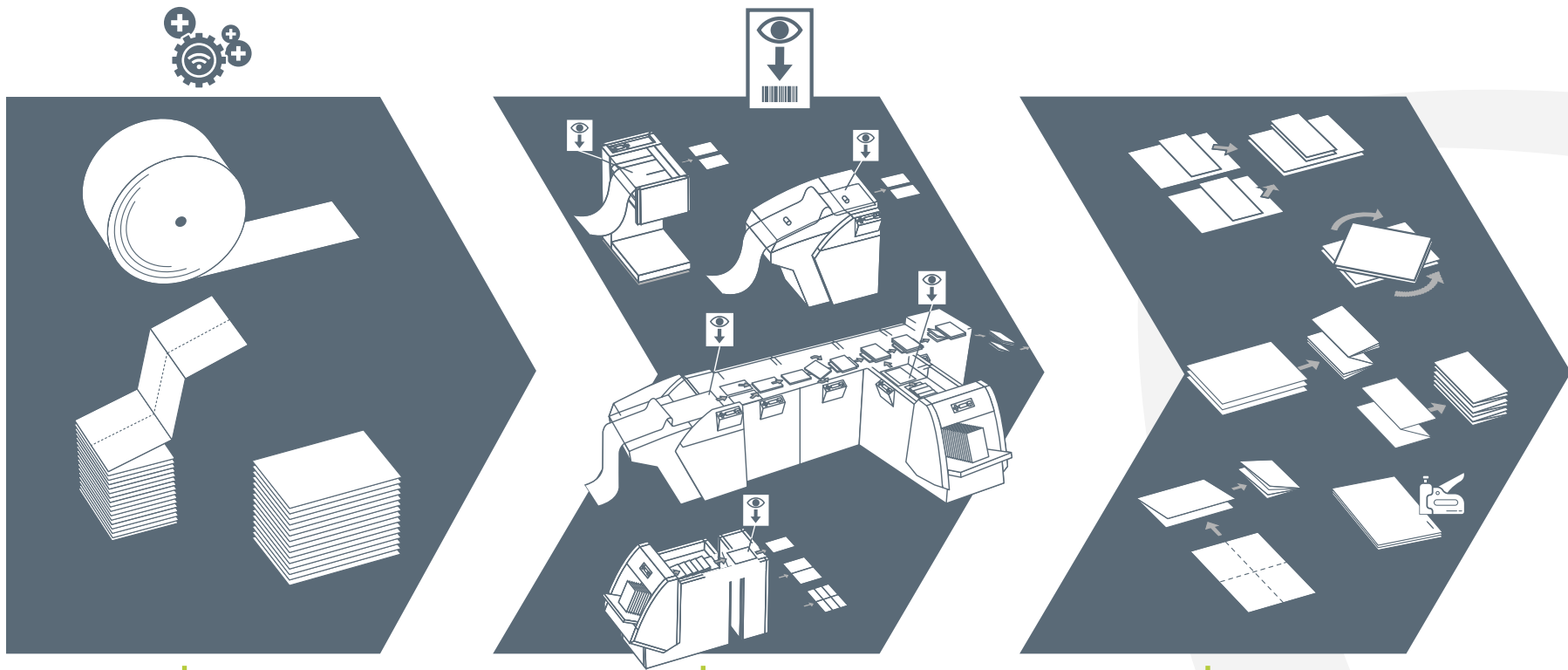

Highly flexible document feeding

Merging of documents

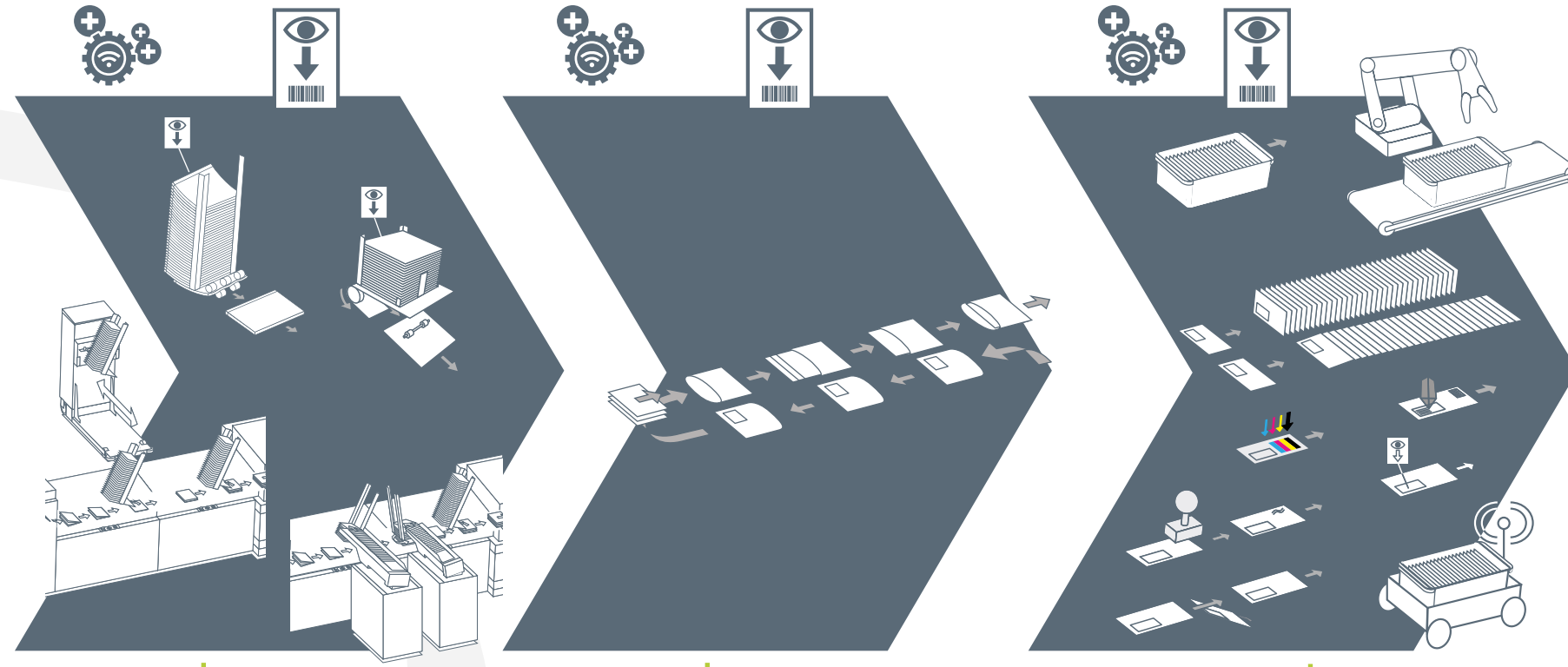

Variety of options for processing different enclosures

Stable, smooth inserting process

Options for even more extensive automation

# AUTOMATED MAILROOM

Other BOWE SYSTEC technologies allow you to integrate upstream or downstream steps that have to date been carried out separately or manually. Flexibly configured and highly capable infeed channels for a variety of assembly, folding or stitching applications. Modules for variable color envelope printing, sorting functions or postal tray systems all expand the functionality of Fusion Series systems and reduce the need for additional special machines and personnel. The use of driverless vehicles or robots paves the way for automated production. Get more out of your mail production center and turn it into the kind of mailroom you have always dreamed of having.

## HIGH-PERFORMANCE SOFTWARE

It is our intuitive software applications that really make the overall package of highly capable technologies fly. The modern software platform Orbiter forms the basis for this in a mail production center. The smart ways in which the systems can be networked with each other and the ability to control them intuitively make the fully automated and ultra-flexible mailroom of tomorrow a realistic prospect today. Integration into a Warehouse Management System also opens up entirely new possibilities for automating your mail production center and enhancing its efficiency.



Process optimizing software (Warehouse Management Systems)

## THE FUSION SERIES AT A GLANCE

### FUSION SPEED

- High volumes
- Fastest & most efficient system on the market
- Highest net output in the industry
- Your route to the automated mailroom

### FUSION CROSS

- High volumes
- Maximum flexibility
- Broadest range of formats & filling thicknesses
- True all-rounder

### FUSION LITE

- Medium volumes
- Premium technology
- Outstanding price-performance ratio
- Very broad range of formats & filling thicknesses

Some features optional, not available for all systems.



## THE FUSION SERIES AT A GLANCE

# MODULAR TO THE CORE

The consistently modular approach to the design of Fusion Series inserters and the range of options available make highly automated production possible.

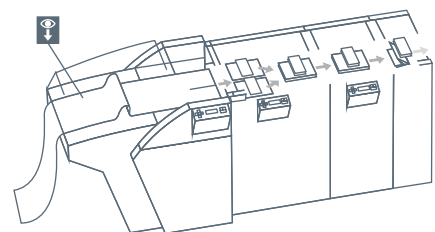

### High performance begins with the infeed channel

Whether cut-sheet or continuous processing, whether single or multi-channel input, the well-thought-out paper infeed concept of BOWE SYSTEC infeed channels allows them to fulfill varied mail production center requirements and deliver maximum efficiency. Top performance is guaranteed by the superfast, high performance input channel with integrated Flow Booster.

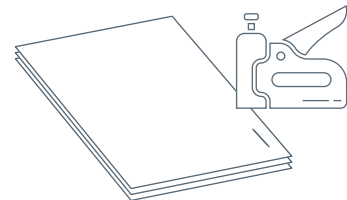

### Policy processing made simple

Every day, output centers produce hundreds of thousands of letters and policies for insurance companies. These consist of numerous different documents and enclosures and need to be sent out to the customer within 24 hours. Our solution for high volume policy production is an assembling and stitching module.

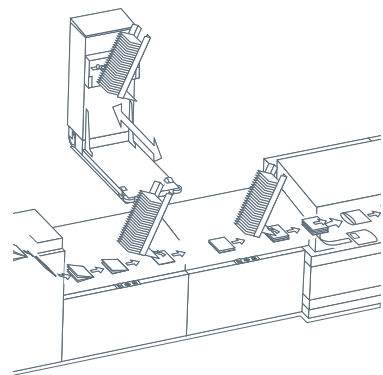

### High enclosure flexibility for handling future applications

The inserting principle and the range of enclosure feeders means that Fusion Series inserters can handle a broad spectrum of enclosures. The open device carrier concept allows flexible use of feeders, while the enclosure Autoloader increases efficiency still further and reduces the strain on operators at high production speeds.

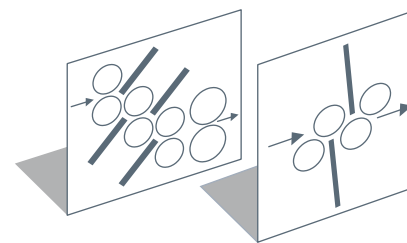

### Perfect fold at top speed

The BOWE SYSTEC pocket folding module means that Fusion inserters deliver perfect folds even at full speed. Versions with two or four folding pockets can fold up to eight or up to 16 sheets simultaneously. Whether Z-, C-, single or double parallel fold, Fusion inserters have the right solution for every application.

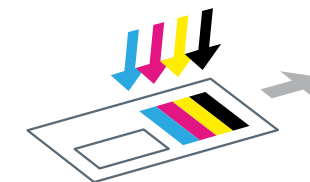

### Brilliant printed results with EPOD envelope printing

Envelope Print On Demand (EPOD) allows logos or individual marketing messages to be printed directly on the envelope in full color. This opens up completely new possibilities for catching the eye and boosting efficiency. As an added bonus, preprinted envelopes no longer need to be stored, which simplifies intralogistics.

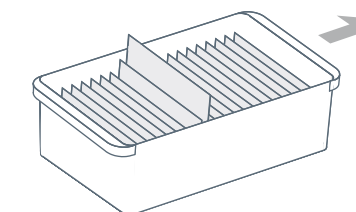

### BOXIT postal tray system: efficient mail logistics

BOXIT is a smart system for automatically filling trays and comes as a standard for Fusion Speed (optionally available for Fusion Cross and Fusion Lite). BOXIT takes the envelopes filled by the inserter and automatically deposits them in the appropriate tray. Optionally, robots can prepare the full trays for onward transport.

Some features optional, not available for all systems.

### FUSION SPEED

- High volumes
- Fastest & most efficient system on the market
- Highest net output in the industry
- Your route to the automated mailroom

### FUSION CROSS

- High volumes
- Maximum flexibility
- Broadest range of formats & filling thicknesses
- True all-rounder

### FUSION LITE

- Medium volumes
- Premium technology
- Outstanding price-performance ratio
- Very broad range of formats & filling thicknesses

# SMART SOFTWARE FOR TOMORROW'S PRODUCTION

Productivity and flexibility are not simply a question of speed. Our software division BOWE IQ offers smart, flexible software solutions throughout its product range, so that you can be confident of being optimally equipped for tomorrow's production. BOWE's Orbiter software platform brings the advantages of

modern software to industrial environments. Complex programming of BOWE SYSTEC systems is a thing of the past. Now you can control your production with transparent, easy-to-use apps.



## BOWE COCKPIT INTUITIVE SYSTEM CONTROL

Fusion Series systems really come into their own in combination with smart BOWE IQ software. They are intuitively controlled via flexible, app-based software solutions. The BOWE Cockpit control app handles overall control of the inserting systems. Complex programming routines are now a thing of the past. All you need to do is to describe the material for processing and the machines are made ready for the production process. At the same time, you lay the foundation for fast, reproducible and automated job changeovers. Your operators will come to prize the transparency and simplicity of this control software, which will not only increase motivation but also shorten setup times and simplify production. The number of errors will be reduced and your systems will be put to more efficient use.



## IDEAL FOR JOBS OF ALL SIZES

The trend towards smaller jobs is a major challenge for many BOWE SYSTEC customers, no matter whether they are involved in direct mail or the transactional segment. Small Batch Processing Software specially developed for Fusion inserters transforms processing of variable short runs into profitable high-speed production. Multiple small jobs are bundled together on a roll and processed fully automatically. The system adjusts itself automatically, so that all the operator has to do is change the enclosures or envelopes.



**MORE ABOUT BOWE IQ**

## THE FUSION SERIES AT A GLANCE

### FUSION SPEED

- High volumes
- Fastest & most efficient system on the market
- Highest net output in the industry
- Your route to the automated mailroom

### FUSION CROSS

- High volumes
- Maximum flexibility
- Broadest range of formats & filling thicknesses
- True all-rounder

### FUSION LITE

- Medium volumes
- Premium technology
- Outstanding price-performance ratio
- Very broad range of formats & filling thicknesses

## BOWE ONE ANALYZING PRODUCTION ANY TIME ANY PLACE

BOWE One provides a route to the Automated Document Factory (ADF) for envelope and card mailing through a multitude of central, cross-system functions. Unlock the benefits of networked production and optimize your processes across systems and locations on the basis of precise, real-time data. By analyzing such data, it is possible to plan workflows even more effectively. Free capacity is identified and resources are exploited more fully. Database-controlled production also guarantees that you never miss a thing: seamless item tracking delivers 100 percent process integrity.



MORE ABOUT  
OUR **SOFTWARE ONLINE**  
OR IN OUR **SOFTWARE BROCHURE**

# NETWORKED PRODUCTION THE INDUSTRY 4.0 WAY

Intuitive, high performance BOWE IQ software allows man and machine to work in perfect harmony. It also lays the foundation for the digital networking of all production that will be a feature of tomorrow's industry - "industry 4.0" - as well as generating relevant data

in real time so that areas for improvement can be identified across multiple locations. The consistent software design across all BOWE SYSTEC systems and the intuitive usability also help to deliver significant increases in productivity.

## THE FUSION SERIES AT A GLANCE

### FUSION SPEED

- High volumes
- Fastest & most efficient system on the market
- Highest net output in the industry
- Your route to the automated mailroom

### FUSION CROSS

- High volumes
- Maximum flexibility
- Broadest range of formats & filling thicknesses
- True all-rounder

### FUSION LITE

- Medium volumes
- Premium technology
- Outstanding price-performance ratio
- Very broad range of formats & filling thicknesses

**FIND YOUR  
LOCAL  
CONTACT**



# BY YOUR SIDE ANYWHERE IN THE WORLD

A high-quality product requires first-class service. That's why we cover the world for you from our headquarters in Augsburg and through our network of about 20 subsidiaries and over 50 general representatives across the globe. Our local service presence helps you maximize your productivity and minimize your downtime. BOWE SYSTEC gives you a dedicated contact who speaks your language and who is reachable 24/7. Short travel distances also mean quick, unbureaucratic support. We are by your side anywhere in the world to make sure your mail production center keeps on running.

24/7

## LEGAL NOTICE

BÖWE SYSTEC GmbH  
Werner-von-Siemens-Str. 1  
86159 Augsburg | Germany  
Phone +49 821 5702-0  
Fax +49 821 5702-234  
info@bowe.com  
www.bowe.com

Managing Director: Joachim Koschier

Registered Office: Lübeck  
Company Registration No.: HRB 10736 HL

VAT Reg. No. in accordance with section 27 a  
Value Added Tax Law: DE 274185634

Responsible for content in accordance  
with § 18 (2) of the German Interstate  
Media Treaty (MStV): Joachim Koschier

All rights reserved. Errors and omissions excepted.  
Images for guidance only.

© BÖWE SYSTEC GmbH

## THE FUSION SERIES AT A GLANCE

### FUSION SPEED

- High volumes
- Fastest & most efficient system on the market
- Highest net output in the industry
- Your route to the automated mailroom

### FUSION CROSS

- High volumes
- Maximum flexibility
- Broadest range of formats & filling thicknesses
- True all-rounder

### FUSION LITE

- Medium volumes
- Premium technology
- Outstanding price-performance ratio
- Very broad range of formats & filling thicknesses

# SMART AUTOMATION SOLUTIONS

Our smart automation solutions have been optimizing workflows and production processes for decades in many different industries. Take advantage of our many years of mail production center experience and find the perfect solution for your requirements.



**MANY YEARS  
OF EXPERIENCE**



**FUTURE-PROOF  
INVESTMENT**



**BY YOUR SIDE  
WORLDWIDE**



**CUSTOMIZED  
SOLUTIONS**

VISIT US AT  
[BOWE.COM/SYSTE](https://www.bowe.com/systec)C



**MORE INFO AT  
BOWE.COM**

developed by  
**BOWE  
GROUP**